

Self-Propelled Scissor Lifts

GS™ -2032, GS-2632 & GS-3232

Specifications

Models	GS-2032		GS-2632		GS-3232	
Measurements	US	Metric	US	Metric	US	Metric
Working height maximum ¹	26 ft	8.10 m	32 ft	9.92 m	38 ft	11.75 m
A Platform height maximum	20 ft	6.10 m	26 ft	7.92 m	32 ft	9.75 m
B Platform height stowed	3 ft 5 in	1.03 m	3 ft 10 in	1.16 m	4 ft 3 in	1.29 m
C Platform length - outside	7 ft 5 in	2.26 m	7 ft 5 in	2.26 m	7 ft 5 in	2.26 m
extended	10 ft 5 in	3.18 m	10 ft 5 in	3.18 m	10 ft 5 in	3.18 m
Slide-out platform extension deck	3 ft	0.91 m	3 ft	0.91 m	3 ft	0.91 m
D Platform width - outside	2 ft 8 in	0.81 m	2 ft 8 in	0.81 m	2 ft 8 in	0.81 m
Guardrail height: fixed rails	3 ft 3 in	0.99 m	—	—	—	—
folding rails	3 ft 7 in	1.10 m	3 ft 7 in	1.10 m	3 ft 7 in	1.10 m
Toeboard height	6 in	0.15 m	6 in	0.15 m	6 in	0.15 m
E Height - stowed						
fixed rails	6 ft 8 in	2.03 m	—	—	—	—
folding rails	7 ft	2.13 m	7 ft 5 in	2.5 m	8 ft	2.43 m
rails folded	5 ft 9 in	1.75 m	6 ft 3 in	1.91 m	6 ft 8 in	2.03 m
F Length - stowed	8 ft	2.44 m	8 ft	2.44 m	8 ft	2.43 m
Length - extended	10 ft 11 in	3.33 m	10 ft 11 in	3.33 m	10 ft 11 in	3.33 m
G Width	2 ft 8 in	0.81 m	2 ft 8 in	0.81 m	2 ft 8 in	0.81 m
H Wheelbase	6 ft 1 in	1.85 m	6 ft 1 in	1.85 m	6 ft 1 in	1.85 m
I Ground clearance - center	3.5 in	8.9 cm	3.5 in	8.9 cm	3.5 in	8.9 cm
- with pothole guards deployed	0.88 in	2.2 cm	0.88 in	2.2 cm	0.88 in	2.2 cm

Productivity

Maximum platform occupancy	2		2		2	
Lift capacity	800 lbs	363 kg	500 lbs	227 kg	500 lbs	227 kg
Extension deck capacity	250 lbs	113 kg	250 lbs	113 kg	250 lbs	113 kg
Drive height	full height		full height		22 ft	6.71 m
Drive speed - stowed	2.2 mph	3.5 km/h	2.2 mph	3.5 km/h	2.2 mph	3.5 km/h
Drive speed - raised	0.5 mph	0.8 km/h	0.5 mph	0.8 km/h	0.5 mph	0.8 km/h
Gradeability - stowed ²	30%		25%		25%	
Maximum outrigger leveling:						
front to back	—	—	—	—	3°	
Maximum outrigger leveling:						
side to side	—	—	—	—	5°	
Turning radius - inside	zero		zero		zero	
Turning radius - outside	7 ft	2.13 m	7 ft	2.13 m	7 ft	2.13 m
Raise / lower speed	28 / 24 sec		28 / 24 sec		55 / 28 sec	
Controls	proportional		proportional		proportional	
Drive	dual front wheel		dual front wheel		dual front wheel	
Multiple disc brakes	dual rear wheel		dual rear wheel		dual rear wheel	
Tires - solid non-marking	15 x 5 in	38 x 13 cm	15 x 5 in	38 x 13 cm	15 x 5 in	38 x 13 cm

Power

Power source	24 V DC (four 6V 225 Ah batteries)		24 V DC (four 6V 225 Ah batteries)		24 V DC (four 6V 225 Ah batteries)	
Hydraulic system capacity	4.5 gal	17 L	4.5 gal	17 L	4.5 gal	17 L

Weight³ / Floor Loading⁴

Weight - ANSI, CSA	3,574 lbs	1,621 kg	4,413 lbs	2,002 kg	5,185 lbs	2,352 kg
Tire load, maximum	1,699 lb	771 kg	1,773 lb	804 kg	1,700 lb	771 kg
Tire contact pressure	113 psi	781 kPa	118 psi	815 kPa	113 psi	781 kPa
Occupied floor pressure	223 psf	10.66 kPa	251 psf	12.01 kPa	291 psf	13.92 kPa

Standards Compliance ANSI A92.6, CSA B354.2, CE Compliance, AS 1418.10

¹ The metric equivalent of working height adds 2 m to platform height. U.S. adds 6 ft to platform height.

² Gradeability applies to driving on slopes, see operator's manual for details regarding slope ratings.

³ Weight will vary depending on options and/or country standards.

⁴ Note: Floor loading information is approximate and does not incorporate different option configurations. It should be used only with adequate safety factors.

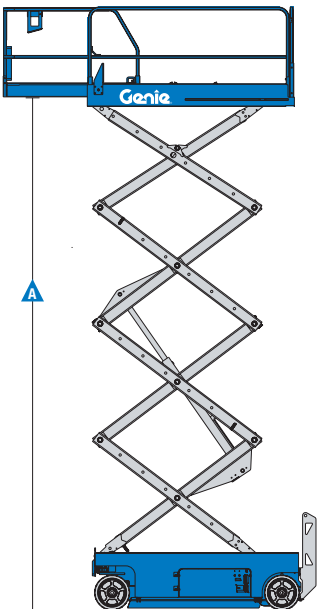
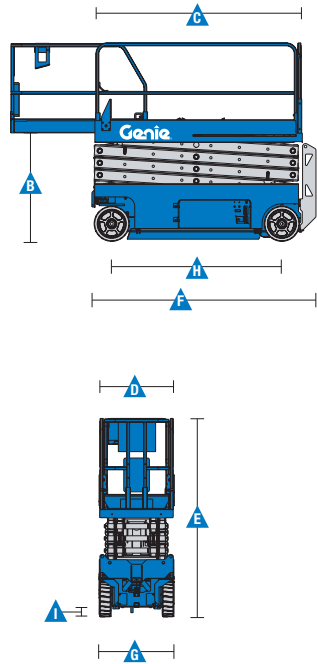

Features

Standard Features

Measurements

GS-2032

- 26 ft (8.10 m) working height
- Up to 800 lbs (363 kg) lift capacity

GS-2632

- 32 ft (9.92 m) working height
- Up to 500 lbs (227 kg) lift capacity

GS-3232

- 38 ft (11.75 m) working height
- Up to 500 lbs (227 kg) lift capacity

Productivity

- 89 x 32 in (2.26 x .81 m) steel platform
- 3 ft (.91 m) extension deck
- Fixed rail with chain entry gate (standard GS™-2032)
- Folding rails with half-height swing gate (standard on GS™-2632, GS™-3232)
- Automatic leveling outriggers (GS™-3232 only)
- Dual front wheel drive
- Universal 27A smart charger
- Rear recessed charger receptacle
- SmartLink™ - proportional lift and drive
- Platform control with battery charge indicator and diagnostic display
- On-board diagnostic system
- AC power to platform
- Lanyard attachment points
- Manual platform lowering valve
- Emergency stop at both platform and ground controls
- Rear wheel multiple disc brakes
- Front wheel hydraulic dynamic braking
- Manual hydraulic brake release
- Swing-out component trays
- Solid non-marking tires
- Pothole guards
- Tilt level sensor with audible alarm
- Dual flashing LED beacons
- Descent alarm
- Electronic horn
- Hour meter
- Motion alarm

Power

- 24 V DC (four 6 V 225 Ah batteries)

Options & Accessories

Productivity Options

- Folding rails with half-height swing gate (GS™-2032)
- Platform swing gate, half-height (GS™-2032)
- Air line to platform
- Automotive horn*
- Biodegradable hydraulic fluid
- Platform control guard

Power Options

- Power Inverter (120 V/60 Hz)¹
- EE rating
- AGM maintenance-free batteries
- Drive cutout while charging



¹ Not available with EE rating

Genie United States

6464 185th Ave. NE
Redmond, WA 98052
Telephone +1 (425) 881-1800
Toll Free in USA/Canada +1 (800)-536-1800
Fax +1 (425) 883-3475

Distributed By:

