



LOADALL | 505-20 TOOL CARRIER

Gross power: 74hp/55kW | Lift capacity: 5,500 lbs | Lift height: 20 feet



PRODUCTIVITY AND PERFORMANCE.

JCB HAS A PROVEN 40-YEAR TRACK RECORD OF DESIGNING AND MANUFACTURING WORLD-BEATING TELESCOPIC HANDLERS FOR THE CONSTRUCTION INDUSTRY. THE NEW COMPACT 505-20 TC IS THE LATEST IN THIS LONG LINE OF MACHINES BUILT FOR MAXIMUM PRODUCTIVITY ON ANY SITE.



Maximum maneuverability.

1 Our 2-speed transmission allows operators to select high and low speeds. The low speed setting complies with building site speed regulations, while high speed is ideal for roading.

2 Hydrostatic transmission makes it easy for operators to achieve precise machine movements even in cramped spaces. The driveline works in parallel with the braking system too; a transmission dump on the foot brake offers superb multi-functioning and increased power during loading and rehandling.

3 For excellent traction and performance in soft, muddy conditions, we've fitted the 505-20 TC with 4WD as standard. Opt for our limited slip differential axle to maximize tractive effort on slippery surfaces. This system transfers drive from the spinning wheel to the stationary wheel.



Excellent maneuverability.

4 Operators can maneuver quickly and easily, with directional shuttle changes possible via either the shuttle lever on the steering column or the joystick mounted shuttle switch

5 With a compact wheelbase and large steering lock angles, tight turning circles and superior maneuverability are assured.

6 This Loadall has three selectable manual steering modes. Two-wheel steer is perfect for roading; four-wheel steer provides great maneuverability in tight spaces; and crab steer is designed to edge your Loadall either close to or away from walls and buildings.

7 Choose our optional electronic selectable 4WS for on-the-move steering mode changes.

A low height of 6' 2" and a narrow width of 6ft enables the 505-20 TC Loadall to access the very smallest operating environments.

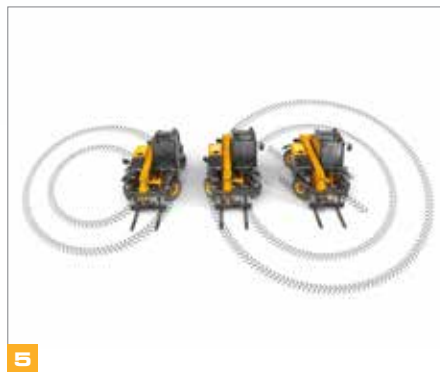



Ultimate productivity.

The 505-20 TC Loadall is great for loading and unloading truck loads of bricks;

8 There's a lift capacity of 1750lbs at 11.5 feet forward reach.

9 You can choose from three manual or hydraulic quickhitch options: JCB Q-fit, compact tool carrier, or skid-steer.

10 A 20ft lift height makes it safe and straightforward to place bricks onto a two story building; lift capacity is 5500 lbs with the boom retracted, or 3900lbs at full height.

11 With single or double auxiliary services, you can operate a sideshift function or hydraulic attachments easily.

STYLE AND DESIGN.

THE LATEST JCB LOADALLS LIKE THE 505-20 TC HAVE BEEN DESIGNED WITH VALUABLE INPUT FROM CUSTOMERS, AND THEY'RE VISIBLY DIFFERENT FROM THEIR PREDECESSORS. THE CHANGES ARE MORE THAN SKIN-DEEP THOUGH; YOU'LL FIND A WEALTH OF INNOVATIVE FEATURES TO COPE WITH THE RIGORS OF HARD WORK ON ANY CONSTRUCTION SITE.



Design that works harder

1 JCB's new-look Loadall exterior isn't purely cosmetic; the cooling fan airflow is now angled upwards, reducing time-consuming dust build-up.

2 The boom pivot point on the 505-20 TC is low down; this helps to provide unrivalled visibility to the right hand rear wheel, often a blind spot on traditional telehandlers.

3 This machine shares key design elements with our larger Loadalls, including the distinctive and innovative side-mounted engine setup.

4 Our slimline outer boom section enables operators to see the front right-hand wheel with ease.

5 To keep the 505-20 TC as narrow as possible, the cab door handle and hinges are fitted flush with the side of the machine.



QUALITY/RELIABILITY/DURABILITY.

SINCE THE VERY BEGINNING, JCB LOADALLS HAVE BEEN PRIZED FOR THEIR HIGH LEVELS OF BUILD QUALITY AND DURABILITY. THE NEW 505-20 TC IS NO DIFFERENT, BENEFITTING FROM ADVANCED PRODUCTION PROCESSES, INTENSIVE TESTING PROCEDURES AND PREMIUM COMPONENTRY.

Strength in depth

1 The one-piece fully welded chassis maximizes strength and minimizes weight.

The Loadall boom is mounted low in the chassis, providing an extremely rigid structure.

2 Heavy-duty axle feet absorb the immense stresses generated during continuous heavy material rehandling.

3 For ultimate strength and durability, we've built in large boom overlaps of up to 2.5ft.

4 We've fitted a tough inverted U-shaped boom pressing with fully welded closing plates. For extra strength, we've reduced the number of joints and stress points across our integrated boom nose and one-piece closing plate.

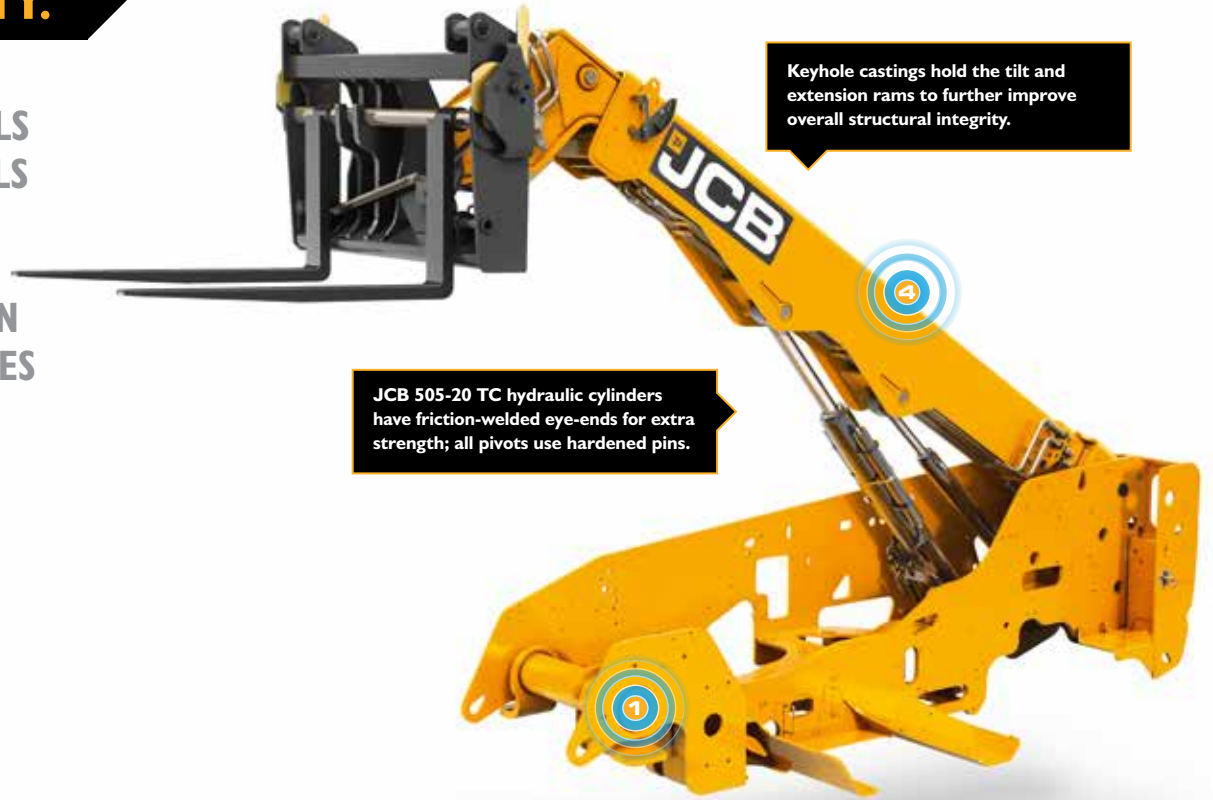

Keyhole castings hold the tilt and extension rams to further improve overall structural integrity.

JCB 505-20 TC hydraulic cylinders have friction-welded eye-ends for extra strength; all pivots use hardened pins.



5

Quality, controlled.

5 Our stringent pre-production test program included prolonged high stress loading of the chassis, boom and other key components, as well as cold climate testing and repeated transmission use over thousands of cycles.

6 We use state-of-the-art manufacturing processes like robot machining, precision paint technology and innovative assembly techniques to achieve the very highest levels of quality.



5



5



6

COMFORT AND EASE OF USE.

IN ORDER FOR A TELEHANDLER TO OFFER ULTIMATE PRODUCTIVITY, IT NEEDS ITS OPERATOR TO BE COMFORTABLE AND FOCUSED. WITH THIS IN MIND, THE 505-20 TC IS EQUIPPED WITH AN OPERATOR AREA THAT'S ALL-DAY COMFY, ERGONOMIC, AND DESIGNED TO ACCOMMODATE INDIVIDUAL PREFERENCES.

Comfortably superior.

1 The JCB 505-20 TC has a large, spacious cab with a wide access door; inside, there's a radio speaker and plenty of underseat storage.

2 This machine has all-new instruments and a hi-res TFT screen. Intuitively laid-out control switches are backlit for optimum night recognition.

3 Tinted cab glass is fitted as standard; 30% of the sun's energy is reflected, increasing operator comfort.

4 So that you can tailor your Loadall for any climate, you can choose from canopy or cab options. Air conditioning is available, ensuring the perfect working environment.



6 Controlling a JCB 505-20 TC is comfortable, precise and smooth: there are single lever electro servo controls with proportional auxiliaries.

7 JCB's proportional constant flow feature allows operators to program different flow rates for different attachments.

8 For operator comfort the productivity enhancing 7-speed fan is fitted as standard and for additional comfort choose our optional tilt/telescopic steering column.

9 You can choose from a variety of seating options to suit all operators and applications.

We've made significant noise pollution reductions over outgoing models; the 505-20 TC is 76dB(A) quieter inside for the operator.



SAFETY AND SECURITY.

ON-SITE SAFETY IS OF PARAMOUNT IMPORTANCE, SO THE 505-20 TC HAS A WEALTH OF FEATURES DESIGNED TO PROTECT ITSELF, ITS OPERATORS AND ANY BYSTANDERS. IT'S ALSO EQUIPPED WITH A COMPREHENSIVE SECURITY PACKAGE.

Protecting people.

- 1 To protect bystanders, we fit a reversing alarm as standard*, and there are also hose burst check valves (HBCVs) on the rams to guard against collapse in the event of a hose failure.
- 2 The cab is Roll Over Protection System (ROPS) and Falling Objects Protection System (FOPS) certified, so you can rest assured that operators are safe at all times.
- 3 A seat safety switch disables forward and reverse controls when your operator isn't seated.
- 4 An optional load guard on the Q-fit carriage provides added protection against material falling from the rear of the carriage.

*UK and Ireland only.



You can opt for a front screen guard for added protection from falling debris.

The 505-20 TC Loadall is equipped with a full set of side mirrors for excellent visibility and full safety compliance.

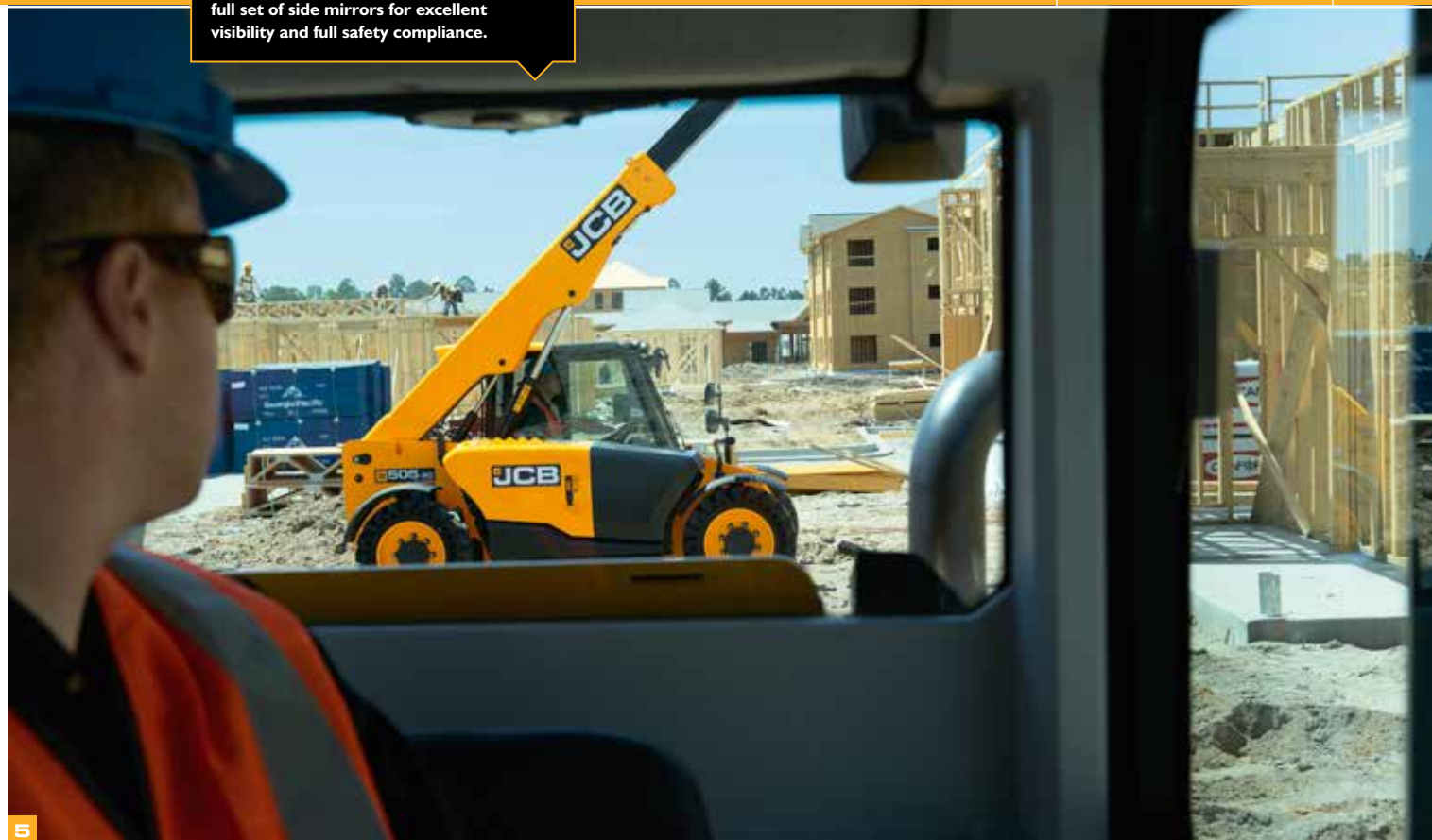

Visibly better.

5 As you'd expect from a JCB Hi Viz machine, all-around visibility is superb via the large roof screen, the opening rear window, the fold-back upper door, and the compact JCB Diesel by Kohler engine unit with its low-level sloping hood. In fact, rear visibility is outstanding thanks to our unique low profile rear chassis and boom.

6 Cab-mounted front and rear worklights provide great visibility. To make it even better (especially when loading at height in dark conditions), opt for our boom-mounted worklights.

Safeguarding your investment.

7 JCB LiveLink's telematic GPS tracking provides invaluable real-time machine location data. Geofencing alerts help to ensure your machine is only being used in your chosen areas.



EFFICIENT ENGINE DESIGN.

JCB LOADALLS HAVE ALWAYS BEEN FOCUSED ON MAKING THE MOST OF EVERY DROP OF FUEL. THE EFFICIENT NEW JCB DIESEL BY KOHLER ENGINE RANGE – AS FITTED TO THE 505-20 TC – TAKES THIS ETHOS TO THE NEXT LEVEL, OFFERING A WINNING COMBINATION OF PERFORMANCE AND FUEL SAVINGS.

Fluid filters on this machine (engine oil, hydraulic oil and fuel) are within easy reach for fast, easy servicing. The air filter is easily accessible too, and a double-element construction simplifies cleaning.

JCB Diesel by Kohler.

The 505-20 TC Loadall is equipped with a potent JCB Diesel by Kohler T4 final (EPA compliant) motor that produces 300Nm of torque at just 1500rpm, and doesn't need costly DPF or AdBlue after-treatment.

Most Tier 4 final engines use a Diesel Particulate Filter (DPF) or SCR, requiring additional AdBlue fluid level maintenance – this JCB Diesel by Kohler engine doesn't.

Because it produces peak levels of torque at engine speeds as low as 1500-1600rpm, this engine can provide fuel-efficient matching of the transmission and hydraulics.



SERVICEABILITY.

ANOTHER KEY TO ULTIMATE PRODUCTIVITY IS MINIMIZED DOWNTIME. OUR ENTIRE LOADALL RANGE, INCLUDING THE 505-20 TC, IS THEREFORE DESIGNED TO KEEP SERVICING AND MAINTENANCE TO A MINIMUM. ROUTINE MAINTENANCE IS, OF COURSE, INEVITABLE, BUT EVEN WHEN IT'S DUE, YOU'LL FIND IT STRAIGHTFORWARD AND SPEEDY.

Easy access.

- 1 All of the 505-20 TC's daily checks and greasing can be done from ground level.
- 2 With its gas-assisted cylinder, the hood is easy to open and close. The service bay within is large and wide enough to afford great access to three sides of the engine.
- 3 The diesel tank is easily accessed and filled from ground level. There's an integral pre-filter in the filler neck as well, offering protection from dirty fuel.
- 4 Hydraulic hoses are intelligently routed through the boom for maximum protection.
- 5 Because the 505-20 TC's wear pads use a dry lubricant system, they only need servicing every 500 hours (compared to 250 hours on typical competitor machines).



COST OF OWNERSHIP.

WE BELIEVE THAT PROVIDING THE VERY BEST VALUE FOR MONEY SHOULDN'T BE RESTRICTED TO OFFERING A HIGHLY EFFICIENT ENGINE PACKAGE. THAT'S WHY THE 505-20 TC HAS A HUGE ARRAY OF EXTRA FEATURES DESIGNED TO KEEP YOUR COST OF OWNERSHIP TO A MINIMUM.

Saving you money.

To save you time and money, JCB's LiveLink telematics suite uses satellite technology to provide valuable real-time data on machine location, movements, health, usage and servicing requirements.

JCB Loadalls are heralded and sought after all around the world for their legendary productivity and build quality. By owning one, you'll benefit from the resulting high residual values.

This engine burns fuel so cleanly that it doesn't require exhaust after-treatment, meaning that you won't need to use costly heat-resistant lube oils.

1 The 505-20 TC is fitted with the flat glazing throughout keeping replacement costs low.

Protected from downtime.

2 The side-mounted engine hood is safely recessed within the machine, providing increased protection from site damage.

3 Steering rams are well out of harm's way, mounted high on the axle. This protects them from damage and minimizes downtime.

4 By electrophoretically dipping the 505-20 TC's cab prior to the painting process, we ensure long-term corrosion protection.

To maintain strong residuals, Loadalls need to look good even after extensive use; that's why we use a powder coat paint process that's robust and resistant to stone chips.





LIVELINK, WORK SMARTER.

LIVELINK IS AN INNOVATIVE SOFTWARE SYSTEM THAT LETS YOU MANAGE JCB MACHINES REMOTELY – ONLINE, BY EMAIL OR BY MOBILE PHONE. ACCESS EVERYTHING FROM MACHINE ALERTS TO FUEL REPORTS AND HISTORY INFORMATION, WITH ALL DATA STORED AT A SECURE CENTER.

Productivity and cost benefits

By providing information like idle time monitoring and machine fuel consumption, JCB Livelink helps reduce your fuel usage, saving money and improving productivity. Machine location information can help improve efficiency and perhaps even reduce insurance costs.

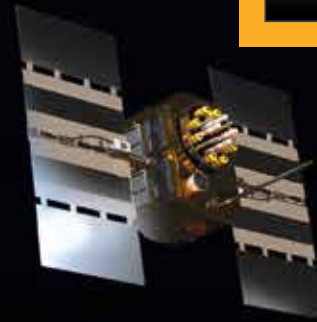

Maintenance benefits

Manage machine maintenance easily – accurate hours monitoring and service alerts improve maintenance planning, while real-time location data helps you manage your fleet. Critical machine alerts and maintenance history records are also available.



Security benefits

Livelink's real-time geofencing alerts tell you when machines move out of predetermined zones, and real-time curfew alerts inform you of unauthorized usage. Further benefits include real-time location information and PIN code management (to remotely authorize usage – perfect for plant hire).



VALUE ADDED.

JCB'S WORLDWIDE CUSTOMER SUPPORT IS FIRST CLASS. WHATEVER YOU NEED AND WHEREVER YOU ARE, WE'LL BE AVAILABLE QUICKLY AND EFFICIENTLY TO HELP MAKE SURE YOUR MACHINERY IS PERFORMING TO ITS FULL POTENTIAL.



1 Our Technical Support Service provides instant access to factory expertise, day or night, while our Finance and Insurance teams are always on hand to provide fast, flexible, competitive quotes.

2 The global network of JCB Parts Centers is another model of efficiency; with 16 regional bases, we can deliver around 95% of all parts anywhere in the world within 24 hours. Our genuine JCB parts are designed to work in perfect harmony with your machine for optimum performance and productivity.



3 JCB Assetcare offers comprehensive extended warranties and service agreements, as well as service-only or repair and maintenance contracts. Irrespective of what you opt for, our maintenance teams around the world charge competitive labour rates, and offer non-obligation quotations as well as fast, efficient insurance repair work.

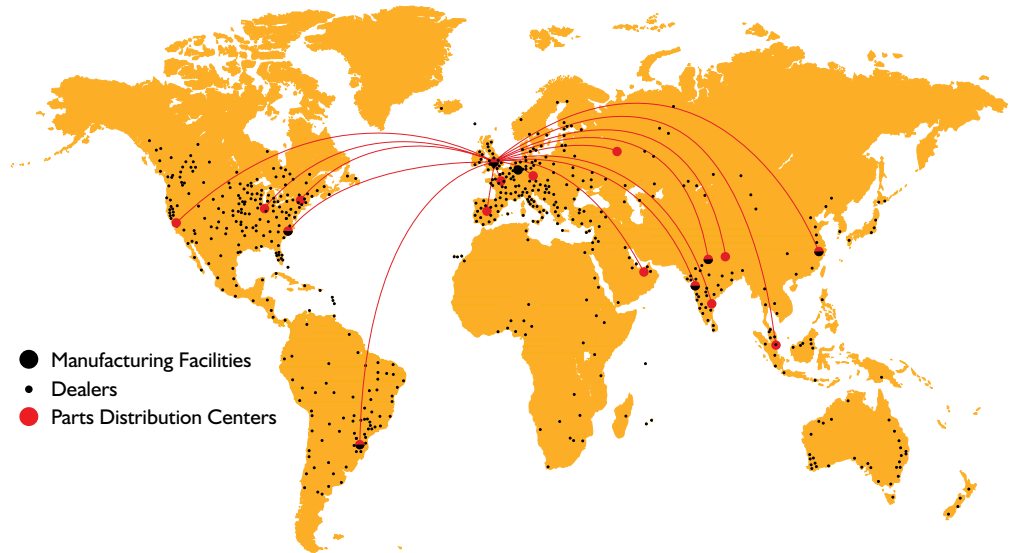

Note: JCB LIVELINK and JCB ASSETCARE may not be available in your region, so please check with your local dealer.

STATIC DIMENSIONS

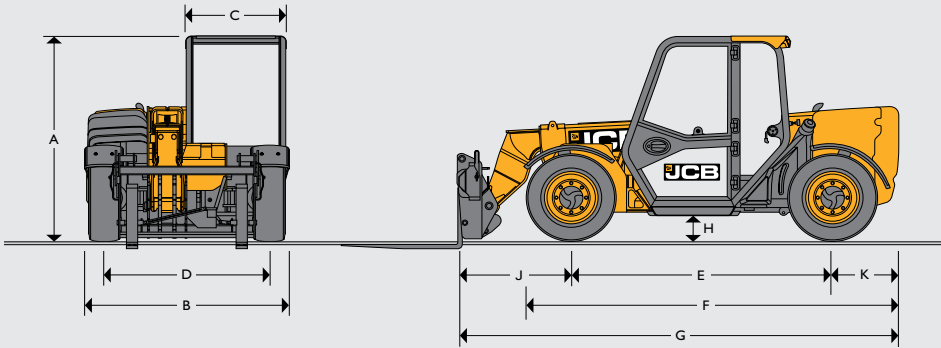

A	Overall height*	ft-in (m)	6-2 (1.89)
B	Overall width (over tires)*	ft-in (m)	6-0 (1.84)
C	Inside width of cab	ft-in (m)	2-11 (0.88)
D	Front track	ft-in (m)	5-0 (1.53)
E	Wheelbase	ft-in (m)	7-10 (2.39)
F	Overall Length to front tires	ft-in (m)	11-1 (3.38)
G	Overall length to front carriage	ft-in (m)	13-1 (4)
H	Ground clearance	ft-in (m)	0-9 (0.23)
J	Front wheel center to carriage	ft-in (m)	3-4 (1.02)
K	Rear wheel center to rear face	ft-in (m)	2-0 (0.6)
	Outside turn radius (over tires)	ft-in (m)	12-1 (3.7)
	Carriage roll back angle	degrees	11
	Carriage dump angle	degrees	114
	Weight	lb (kg)	12100 (5490)
	Tires	industrial	12 x 16.5

*Dependent upon tire specified

LIFT PERFORMANCE

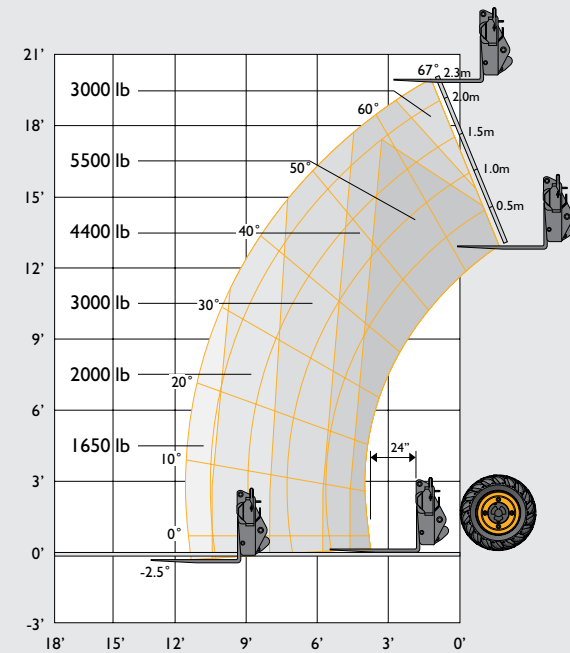

Maximum lift capacity	lb (kg)	5500 (2500)
Lift capacity to full height	lb (kg)	3900 (1750)
Lift capacity at full reach	lb (kg)	1750 (800)
Lift height	ft-in (m)	20-0 (6)
Reach at maximum lift height	in (m)	-6 (-0.15)
Maximum forward reach (to front of carriage)	ft-in (m)	11-6 (3.5)
Reach with 2,600 lbs load	ft-in (m)	8-7 (2.64)

Complies with stability test ANSI B56.6.

ENGINE

Latest Tier 4 Final technology and advanced design provides low fuel consumption, reduced noise, high torque and power output, total reliability and minimal maintenance. Two-stage, dry type air filter with primary and safety elements. Territory dependent.

Manufacturer	JCB DIESEL BY KOHLER		
Displacement	ltr	2.5	
No. of cylinders	4		
Bore size	in (mm)	3.46 (88)	
Stroke	in (mm)	4 (102)	
Aspiration	Turbocharged cooled		
Power rating			
Power @ 2200rpm	hp (kW)	74 (55)	
Torque rating			
Torque @ 1500rpm	lb-ft (Nm)	221 (300)	

HYDRAULICS

Two stage gear pump, fitted with suction strainer and filter. One boom end auxiliary hydraulic service fitted as standard.

Operating system pressure	psi (bar)	3408 (235)	
Flow at system pressure @ 2200rpm	g/min (l/min)	21 (80)	
Hydraulic cycle times		Seconds	
Boom raise	7.6		
Boom lower	5.3		
Boom extend	7.5		
Retract	3.7		
Bucket dump	1.9		
Bucket crowd	2.9		

TRANSMISSION

Closed loop variable displacement pump with a continuously variable hydrostatic drive. Comprising of a hydraulic motor and control unit. Permanent 4 wheel drive. Travel speed: 15mph (25kph).

		Forward	Reverse
Low range	mph (kph)	5 (8)	5 (8)
High range	mph (kph)	15 (25)	15 (25)

ELECTRICS

System voltage	Volt	12
Alternator output	Amp hour	80
Battery capacity	Amp hour	120

NOISE AND VIBRATION

		Uncertainty		Measurement conditions
Noise at the operator station	LpA	76 dB	+/- 1 dB	Determined in accordance with the test method defined in EN12053.
Noise emission from the machine	LWA	103 dB	+/- 1 dB	Guaranteed equivalent sound power (external noise) determined in accordance with the dynamic test conditions defined in 2000/14/EC.
Whole body vibration	m/s ²	0.37	0.18	ISO 2631-1:1997 normalised to an 8h reference period and based upon a test cycle defined in SAE J1166.
Hand-arm vibration	m/s ²	<2.5	N/A	ISO 5349-2:2001 dynamic test conditions.

AXLES

Front and rear drive axles: epicyclic hub reduction drive/steer axles with torque proportioning differentials.

BRAKES

Service brakes: Hydraulically operated self-adjusting, oil-immersed in-board multi-disc type mounted on front axle.

Parking brake: SAHR Handbrake self adjusting, oil immersed in-board multi disc type mounted on front axle operated by in-cab switch.

SERVICE FILL CAPACITIES

Hydraulic system	gal (litres)	17 (65)
Fuel tank	gal (litres)	20 (75)

BOOM AND CARRIAGE

Boom is manufactured from high tensile steel. Low maintenance, hard wearing pads. JCB Q-Fit, Skid-Steer.

STEERING

Hydrostatic power steering with power track rods on both axles.

Three steer mode options: Front wheel steer, all wheel steer, crab steer, operated from in the cab by a selection lever.

Option: In cab selector switch with Auto Align.

CAB

Quiet, safe and comfortable cab conforms to ROPS ISO 3471 and FOPS ISO 3449. Tinted, flat glass all around, with laminated roof screen. Roof bars, front screen with wipers and heater/screen demister. Rear opening window with wash/wipe. Audio-visual warning system for coolant temperature, engine oil pressure, air-cleaner, battery charge, transmission oil temperature and pressure, water in fuel, hourmeter, road speed indicator, fuel gauge, engine temperature, clock and inclinometer. Adjustable suspension seat, tilt steer column, park brake, floor mounted throttle and brake pedals.

Hydraulic controls: Single lever servo joystick, incorporating forward/neutral/reverse, with progressive extend/retract and auxiliary incorporating constant flow facility.

OPTIONS

Options: Canopy, front and rear working lights, rotating flashing beacon, fire extinguisher, front screen guard, air conditioning, 2 boom end auxiliary services, sunblind, radio kit, hydraulic locking carriage, limited slip differential in front axle, air suspension seat, 2-speed and intermittent front wash/wipers.

Attachments: Contact your local dealer for details of the comprehensive range, full road light kit, 12 volt in-cab socket, face level fan, tilt and rake steering column



ONE COMPANY, OVER 300 MACHINES.

Your nearest JCB Dealer

JCB North American – Headquarters

2000 Bamford Blvd., Savannah, Georgia, 31322 Tel: (912) 447-2000

Download the very latest information on this product range at www.jcb.com

JCB inc. All rights reserved. No part of this publication may be reproduced, stored in a retrieval system, or transmitted in any form or by any other means, electronic, mechanical, photocopying or otherwise, without prior permission from JCB inc. All references in this publication to operating weights, sizes, capacities and other performance measurements are provided for guidance only and may vary dependant upon the exact specification of machine. They should not therefore be relied upon in relation to suitability for a particular application. Guidance and advice should always be sought from your JCB Dealer. JCB reserves the right to change specifications without notice. Illustrations and specifications shown may include optional equipment and accessories. The JCB logo is a registered trademark of J C Bamford Excavators Ltd.

9999/0000 en-US 02/17 Issue 1 DWUSA 4437

[f /JCBNA](https://www.facebook.com/JCBNA)
[t /JCBNA](https://twitter.com/JCBNA)
[v /JCBNORTHAMERICA](https://www.youtube.com/channel/UCv3v3v3v3v3v3v3v3v3v3v3)

